

# **Bona<sup>®</sup>**

## Bona Belt HD

by



**KÜNZLE & TASIN**



## Owner & Operation Manual

Manual is compatible with Künzle & Tasin Taurus

This manual contains important information on the safe use and operation of this machine.

Failure to read this manual before operating, adjusting or servicing this machine could cause injury or damage to persons or objects.

Anybody operating the machine should understand how to use and operate it before starting it up.

Keep this manual for future reference.

This manual is an **ENGLISH** translation of the original version in Italian.



**KÜNZLE & TASIN**

For a new manual contact:  
**Kunzle & Tasin S.r.l.**

REGISTERED HEADQUARTERS  
Via Circonvallazione est, 2/6  
27023 Cassolnovo (PV) - Italy

OPERATIONAL HEADQUARTERS  
Via Cajkovskij, 14  
20092 Cinisello Balsamo (MI) - Italy

Tel. +39 02 66040930  
Fax +39 02 66013445  
[info@kunzletasin.com](mailto:info@kunzletasin.com)  
[www.kunzletasin.com](http://www.kunzletasin.com)

**Contents**

<b>Key for machine symbols</b>	<b>4</b>
<b>Operator safety instructions</b>	<b>4</b>
<b>Storage</b>	<b>5</b>
<b>Transporting and handling the machine</b>	<b>5</b>
Transport with one person	5
Transport with two people	7
<b>Introduction</b>	<b>8</b>
Information on safe use	8
Correct use	8
Machine data plate	8
<b>Commencing operation</b>	<b>9</b>
Instructions for assembly following transportation	9
Instructions for electrical connection	10
Cables, extensions and plugs	11
Instructions on removing sawdust generated during use	11
<b>Recommendations on prevention measures for users</b>	<b>12</b>
Personal safety measures	12
Compliance with safety measures and warnings	12
<b>Instructions on correct machine use</b>	<b>13</b>
<b>Machine specifications</b>	<b>15</b>
<b>Machine warnings</b>	<b>16</b>
Prohibited use	16
<b>Starting the machine</b>	<b>16</b>
<b>Machine adjustment procedures</b>	<b>20</b>
Procedures for centring the abrasive belt	20
Adjusting sanding pressure	21
Wall edge castor	22
Wheel adjustment (on a surface parallel to the axis of the drum)	22
<b>Routine maintenance to be performed</b>	<b>23</b>
Sawdust chamber (for the user)	23
Drums (for the user)	24
Wheels (for the user)	24
Dust bag (for the user)	24
Belt tension (for the user)	25
Bearings (only for Technical Support Service)	25
Drum pulleys and suction fan pulleys (for the user)	26
<b>Spare parts</b>	<b>26</b>
<b>Emergency situations (for the user)</b>	<b>27</b>
Faults	27
Causes	27
Solutions	27
<b>Declaration of Conformity</b>	<b>28</b>
<b>Disposal</b>	<b>29</b>
<b>Diagrams</b>	<b>30</b>

Key for machine symbols

	<b>READ THE INSTRUCTIONS CONTAINED IN THIS USER AND MAINTENANCE MANUAL BEFORE USING THE MACHINE</b>
	<b>HEARING PROTECTION DURING USE IS RECOMMENDED</b>
	<b>PROTECTION OF THE AIRWAYS DURING USE IS RECOMMENDED</b>
	<b>HAZARD DUE TO ELECTRICITY</b>
	<b>HAZARD DUE TO MOVING PARTS</b>

Operator safety instructions

<b>HAZARD</b>	means	Failure to comply with <b>HAZARD</b> notices on the machine or in this manual may result in death or serious injury to the operator or other people. Read and comply with all <b>HAZARD</b> notices on the machine or in this manual.
<b>WARNING</b>	means	Failure to comply with <b>WARNING</b> notices on the machine or in this manual may result in injury to the operator or other people. Read and comply with all <b>WARNING</b> notices on the machine or in this manual.
<b>CAUTION</b>	means	Failure to comply with <b>CAUTION</b> notices on the machine or in this manual may result in injury to the operator or other people. Read and comply with all <b>CAUTION</b> notices on the machine or in this manual.

**HAZARD:**

Failure to read the **BELT HD TAURUS** machine manual before operating, adjusting or performing maintenance operations on the machine could cause injury or damage to persons or objects. Anyone operating the machine should understand how to use and operate it before starting it up.

## Storage

It is advisable to store the machine in its original packaging. Doing so makes it possible to form a column of two packages maximum, with one on top of the other.

If the machine is removed from the original packaging and is not used for some time ensure the wheels and drum are not in contact with the ground. In this case use two supports at least 50mm in height to rest the machine on, ensuring contact is with the base frame.

### WARNING

This equipment is for dry use only and must not be used or kept outside in wet conditions. Store the machine in a dry building, otherwise the machine could be damaged.  
Storage temperature from -20°C to 50°C.

## Transporting and handling the machine

### Transport with one person

### WARNING

The machine is heavy therefore remove the motor and handle unit before it is transported. Ask for assistance to transport the three parts.

The machine can be dismantled into three parts to facilitate transportation:



Motor



Suction tube  
and handle unit



Base frame with drum

Proceed as follows:

1. Ensure the power supply cable is disconnected from the mains and the machine.
2. Open the belt guard after unscrewing the screws with the tool provided.

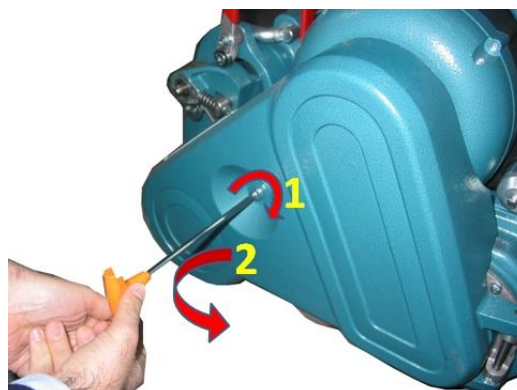

**Transporting and handling the machine**

**Transport with one person**

3. Loosen the belt tightener using the lever (**pos. 2 fig. A**) and remove the belts.



4. Loosen the knob (**pos. 3 fig. A**) until the hollow washers positioned on the motor support shaft slip out from their support housing.

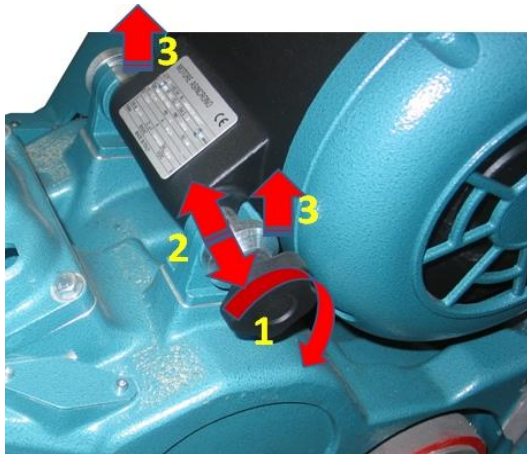

5. Remove the motor and take it to the work area.



6. After lowering the lever (**pos. 4 fig. A**) lift the tube (**pos. 5**) and release the bar (**pos. 6**) from the cylinder (**pos. 8**).

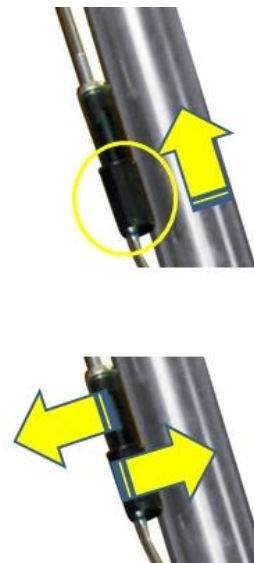

**Transporting and handling the machine**

**Transport with one person**

7. Loosen the handle (**pos. 9 fig. A**) and remove the tube from its housing and bring it to the place of work.
8. Lift the base frame by clasping the front and back. Bring the belt guard to the edge and take it to the work area.

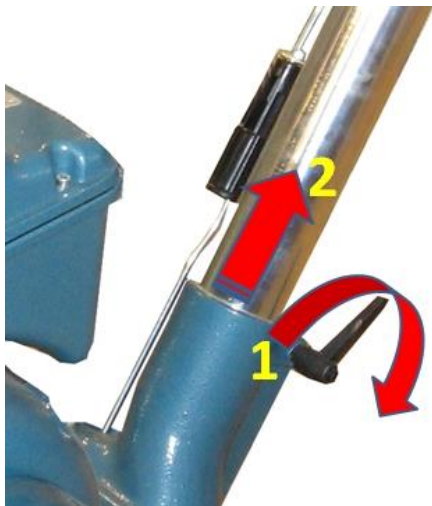

**Transporting and handling the machine**

**Transport with two people**

When transporting the machine with two people proceed as follows:

1. One operator should clasp the handle grip and
2. the second, holding the hub of the belt guide (**pos. 1 fig. A**), should lift the machine



**WARNING**

This equipment is not to be used by anyone (children included) with physical or mental disabilities, or anyone without the relevant experience and knowledge, unless they have received instructions on using the equipment and are supervised by a responsible person to ensure their safety. Children must be supervised to ensure that they do not play with the machine.

## Introduction

### Information on safe use

This instruction manual should be read carefully before using the BELT HD TAURUS wood flooring sander for the first time.

The instruction manual contains important information on safety and preventing improper use of the machine and will resolve any doubts or questions, making it possible to operate the machine safely and with ease.

Removing safety features could cause death or physical injury.

Familiarise yourself with the machine before using it for the first time.

If a situation arises which has not been described in this manual contact your retailer or Kunzle & Tasin s.r.l.

### Correct use

The BELT HD TAURUS wood flooring sander is suitable for the dry sanding of wood floors. Any other use without the consent of the manufacturer is prohibited.

Do not use on wet floors.

See also Prohibited Use on page 13.

Keep hands and clothing away from moving mechanical parts.

The work area is protected via the base frame and the mobile cover on the abrasive drum.

### Machine data plate

The following information can be found on the machine data plate:



1. Machine model
2. Safety symbols
3. Motor power
4. Frequency
5. Supply voltage
6. Name of manufacturer
7. Country of manufacture
8. Year of manufacture or see serial number

#### 9. Serial number:

The serial number is formed as follows:

- the first two numbers refer to the year of manufacture (13 = 2013)
- the second group of three numbers indicates the date the machine was manufactured (029 = 29th January)
- the last two numbers indicate the progressive number of machines produced on that day of manufacture (16 = sixteenth machine)

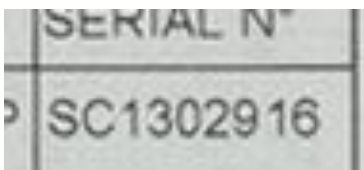



**Commencing operation**

Instructions for assembly following transportation

To re-assemble the machine following transportation proceed as follows:

1. Open the belt guard.

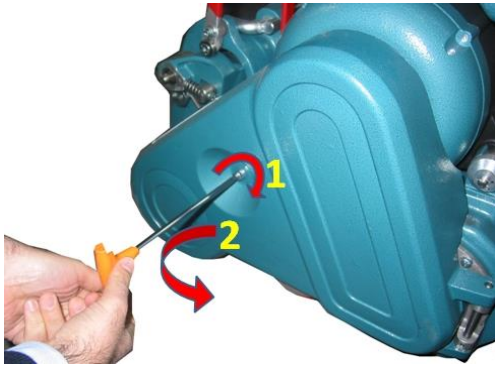

2. Position the motor in its housing.



3. Secure the motor by tightening the knob (pos. 3 Fig A)

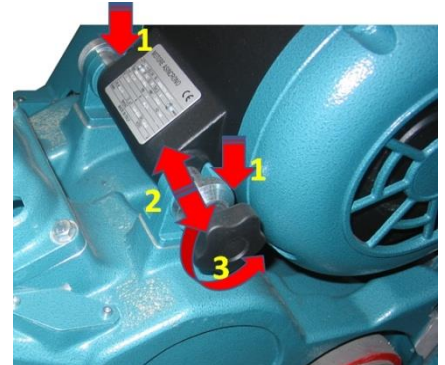

4. Fit and stretch the belts.



5. Close the belt guard by tightening the screws.

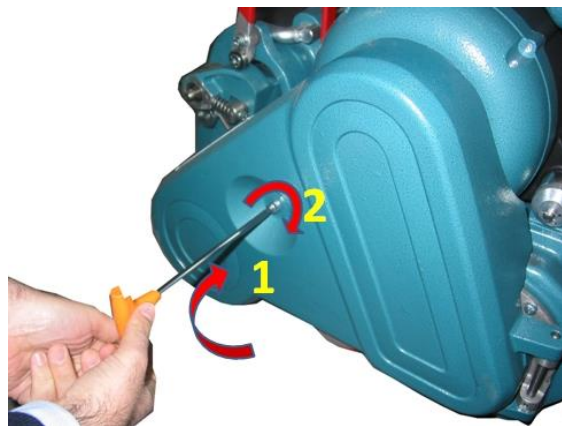

**CAUTION**

Excessive belt tension may cause the premature failure of the ball bearings. The drum belt must have a 10.5 mm stretch with a centre load of  $30 \pm 3N$ . Belt tension can be adjusted using the screw (pos. 1 fig. A) The vacuum cleaner belt must have a 8 mm stretch with a centre load of  $18 \pm 2N$ . The belt tension can be adjusted using the belt tightener.

**HAZARD**

Using the machine when not fully assembled may cause injury or damage to people or objects. Do not use the machine when it is not fully assembled. Keep all fittings tightly closed. Maintain machine settings in accordance with the specifications.

**Commencing operation**

Instructions for assembly following transportation

6. Pull the belt tightener as shown:

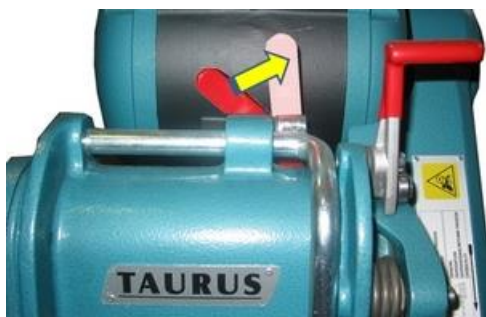

7. Fit the suction pipe and drum control rod.

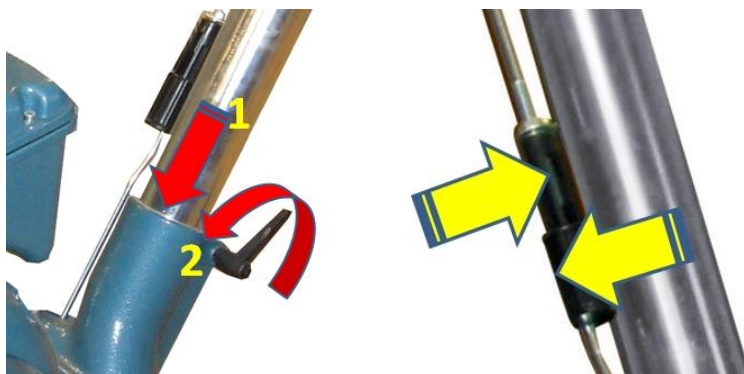

8. Lift the drum with the lever (pos. 4 fig. A).



9. Connect the power supply cable to the machine and power supply.



Instructions for electrical connection

**CAUTION**

This machine only operates with the voltage and frequency shown on the machine data plate. Before connecting the cable to the power supply ensure the correct voltage and frequency are available.

**WARNING**

Do not expose the machine to rain. This machine is intended for dry use only. Keep the machine in a dry building and do not use it in damp or wet places.

**WARNING**

If the machine is not connected correctly to the electricity network death due to electrocution may occur. To prevent electric shocks always use a three wire electrical system connected to earth. For maximum protection against electric shocks use a circuit protected with a differential cut-out switch.

**WARNING**

Tampering with the earthing plug in any way may result in death from electrocution. Do not cut, remove or break the earthing plug. If the socket does not match the plug consult a qualified electrician.

**HAZARD**

If the machine is used with a damaged plug or power supply cable death may occur from electrocution. If cables or plugs are worn or damaged in any way, have them replaced by the manufacturer or the K&T technical support service or similarly qualified person, in order to prevent risks to safety.

**Commencing operation**

**Cables, extensions and plugs**

Only use approved cables. The maximum recommended cable length is 7m; for greater lengths use cables with a larger cross-section.

- CAUTION** Using the machine with unsuitable cable cross-sections and/or excessively long cables may cause injury or damage to people or objects.
- WARNING** The machine must never be moved using its cable and the cable must never be pulled when disconnecting from the socket.
- WARNING** Keep the cable away from sources of heat, oil and sharp edges.

**WARNING**

**MACHINE WITH 230V~ 50Hz SINGLE PHASE MOTOR**

For machines with a 230V~50Hz single phase motor (Europe), a HO5VV-3x2,5 mm<sup>2</sup> HAR-approved power supply cable must be used along with an approved 2P+T 32A 200÷-250V plug.

**MACHINE WITH 380V~ 50Hz TRIPLE PHASE MOTOR**

For machines with a 380V~50Hz triple phase motor (Europe) only use approved four wire cables with three main wires and one earth.

**MACHINE WITH 220V~ 60Hz SINGLE PHASE MOTOR**

For machines with a 220V□ 60Hz single phase motor use a HAR approved SWO 10/3 yellow power supply cable and TWIST LOCK 30A 250V plug.

**Commencing operation**

**Instructions on removing sawdust generated during use**

- HAZARD** Sawdust can ignite spontaneously and cause injury or damage. Empty the contents of the dust bag when it is 1/3 full. Empty the dust bag at the end of each machine use. Never leave the dust bag unattended when it contains sawdust. Do not empty the contents of the dust bag above a fire.



**Recommendations on prevention measures for users****Personal safety measures**

- WARNING** Sawdust can spread through the air and be inhaled when using the sander. Always wear a dust mask when using the sanding equipment.
- WARNING** The eyes and/or body may suffer injury if personal safety clothing is not used. Always wear safety goggles, protective clothing and a dust mask during sanding operations.
- WARNING** Lengthy exposure to noise levels during sanding operations may damage the hearing. Always use ear protectors during sanding operations.
- CAUTION** Never become distracted during sanding operations, check what is happening continually. Use common sense. Do not use the machine when tired.

**Compliance with safety measures and warnings**

- HAZARD** Using the machine when not fully assembled may cause injury or damage to people or objects. Do not use the machine when it is not fully assembled. Keep all fittings tightly closed. Maintain machine settings in accordance with the specifications.
- HAZARD** Using the sander without the safety guards and covers in position may cause injury or damage. Always ensure that all safety guards and covers are in position and secured well.
- HAZARD** The wood flooring sander may create an explosive environment. Cigarettes, cigars, pipes, lighters, pilot flames, or any other source of fire may create an explosion if lit during sanding operations. No sources of fire must be kept near the work area.
- HAZARD** Poorly ventilated work areas may create an explosive environment when some combustible materials are present in the atmosphere, such as solvents, thinners, alcohol, fuel, some paints, wood dust or other combustible materials. Floor sanding machines may cause various materials and fumes to ignite. Read the manufacturer's instructions for each chemical product used and establish its combustibility. Always keep the work area well-ventilated.
- HAZARD** Striking nails when sanding may generate an explosion or fire. Always ensure all nails are sunk before sanding surfaces.
- HAZARD** Serious damage may occur if the power supply circuit trips repeatedly or is undersized. Have the fuses, safety circuit and power supply line checked by an authorised electrician.
- HAZARD** Performing maintenance and/or repairing the machine when it is not fully disconnected from the power supply may cause death due to electrocution. Disconnect the power supply before carrying out any maintenance and/or repair work.
- HAZARD** The use of this machine on a circuit which is not earthed may cause death due to electrocution. Never disconnect or disable the earthing conductor. Consult an electrician if the earth conductor is missing or it is suspected that the circuit is not suitably earthed.

**Recommendations on prevention measures for users**

## Compliance with safety measures and warnings

<b>HAZARD</b>	The use of this machine with a damaged power supply cable may cause electric shock. Check the power supply cable regularly for damage such as splitting or wear and tear. Do not use the machine if the power supply cable is damaged. Do not use the electric cable to move the machine.
<b>HAZARD</b>	Injury or damage may occur if the sander runs over the power supply cable and it becomes damaged. Keep the cable away from the lower part of the machine to avoid contact with the abrasive. Always keep the power supply cable raised above the machine.
<b>HAZARD</b>	The moving parts on this machine may cause serious injury and or damage. Keep hands, feet and loose clothing away from all moving parts of the sander.
<b>HAZARD</b>	Performing maintenance or replacing the dust bag may cause injury to the operator or people nearby if the machine is connected to the power supply.
<b>WARNING</b>	Failure to comply with instructions on this machine and in this manual may cause serious injury and/or damage. Read and comply with all safety instructions. Ensure that all plates, labels, warnings and instructions are secured to the machine. New plates can be obtained from an authorised <b>K&amp;T</b> dealer.
<b>CAUTION</b>	Injury or damage may occur if maintenance operations or repairs are carried out by unauthorised personnel.
<b>CAUTION</b>	The machine may become damaged if it is not kept in a dry building. Keep the machine in a dry building.

**Instructions on correct machine use**

Read this manual carefully and become familiar with the machine.

The equipment is suitable for industrial use e.g. in hotels, schools, hospitals, offices, factories and shops.

The following information highlights particularly hazardous situations for the operator and/or machine.

Understand when these conditions may be present.

Removing safety features could cause death or physical injury.

Take all steps necessary to instruct personnel who may use the machine.

Report any damage on the machine or incorrect operation immediately.

1. Keep hands and clothes away from rotating parts.
2. Keep hands on the handle when the motor is operating.
3. Do not leave the machine unattended when the motor is operating.
4. Always use the machine with the dust bag in the correct position.
5. Do not detach the dust bag with the motor operating.
6. Always disconnect the power supply cable from the machine before performing maintenance.
7. Transport the machine with care due to the heavy weight of the individual parts making up the machine.
8. Always use the machine in well-ventilated areas.
9. Always dispose of the sawdust appropriately.
10. Use the type and amount of abrasive specified in the instruction manual.

Instructions on correct machine use

11. Always keep the work area well-lit.
12. The use of accessories other than those recommended in this manual may cause injury.
13. The sander is for indoor use only.

<b>Abrasive belt dimensions:</b>	750 x 203 mm
<b>Drum width:</b>	200 mm
<b>Drum diameter:</b>	185 mm
<b>Drum speed:</b> 50 Hz 60 Hz	1800-2050 revs/min 2000-2200 revs/min
<b>Motor:</b> (A04) EUROPE	230V ~ 50 Hz 2.99 kW
(A06) EUROPE	380V ~ 50 Hz 2.99 kW 230V ~ 50 Hz 2.5 kW
(A05) UK	240V ~ 50 Hz 2.99 kW
(A03) USA	220V ~ 60 Hz 3 kW
<b>Control lever:</b>	grip control
<b>Level control:</b>	via wheel cam
<b>Safety motor protection:</b>	THERMAL (A04) European, (A05) UK In the event of a power cut the motor will not start without manual intervention.
<b>Wheels:</b>	Ø 112 and 87 mm replaceable
<b>Bearings:</b>	lifetime lubricated ball bearings
<b>Drum pressure adjustment:</b>	infinite adjustment
<b>Noise level (IEC 60704 -1)</b> (continuous weighted sound pressure level A, measured at a distance of 0.4 m from the handle and a height of 1.5 m from the ground)	87.5 dB(A) max
<b>Machine dimensions (assembled)</b>	1045 x 382 x 980 mm
<b>Net weight</b>	85 kg
<b>Gross packaging dimensions</b>	1 cardboard item on base pallet 830 x 536 x 760 mm
<b>Gross weight</b> Cardboard packages	95 kg
<b>Standard equipment</b>	Dust bag Start-up keys User and maintenance manual

## Machine warnings

### Prohibited use

#### WARNING

This equipment is not to be used by anyone (children included) with physical or mental disabilities, or anyone without the relevant experience and knowledge, unless they have received instructions on using the equipment and are supervised by a responsible person to ensure their safety.

#### WARNING

This equipment is not suitable for collecting hazardous dust.

#### CAUTION

Using the machine to move objects or moving on an incline may cause injury or damage. The machine must only be used to sand dry wooden floors which are level or have a maximum incline of 2%. Do not use the machine to sand furniture. Do not sit astride the machine when it is operating.

#### CAUTION

Work surfaces may be seriously damaged if the machine is left turning on one point while the tool is in contact with the surface. To avoid damaging the surface approach the cutting line carefully. Do not stop when lowering and raising the equipment, keep moving at constant speed.

## Starting the machine

To start the machine proceed as follows:

1. Become familiar with the machine and read all instructions and safety notices. Ensure that all operators have read this manual.
2. Arrange the dust bag as indicated by the yellow arrow and secure it with the cord.



3. Locate the power supply. The socket must be compatible with the plug. To avoid electrical hazards the socket must be earth protected with a 20 A fuse.
4. Wind the cable round the cable safety arm (as shown in the photo at the side) to keep it away from the path of the machine.





**Starting the machine**

5. Open the side guard (fig. C.

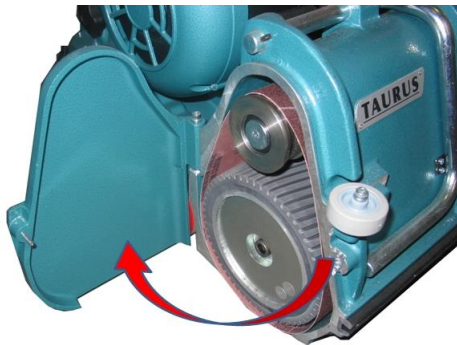

6. Lower the tensioning unit using the drum tensioning lever.

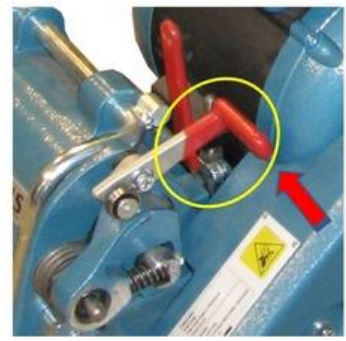

7. Insert the abrasive belt letting it protrude by approximately 2 mm.

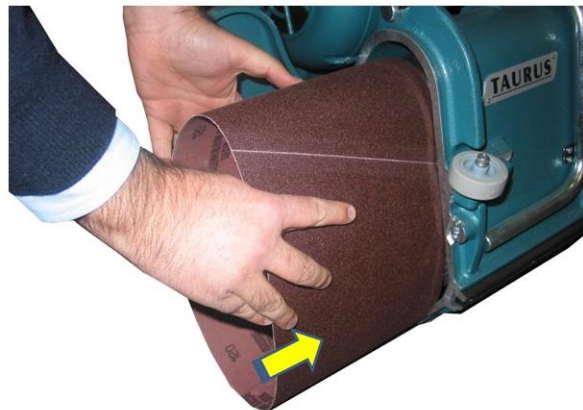

**WARNING**

Only use 750x203 mm abrasive belts.

8. Tension the unit using the drum tensioning lever.



**Starting the machine**

9. Connect the plug to the socket.



10. Ensure the lever is lowered (pos. 1 fig. A) and the drum is raised off the floor.



11. Starting up:

**a) SINGLE PHASE MOTOR**

- 1- Turn the lever on the switch (**pos. 10 fig. B**) from **0** to the **START** position.
- 2- Keep it in this position until the motor has reached a sufficient rotation speed.
- 3- Release the lever on the switch which will automatically return to work position **1**.



**b) THREE PHASE MOTOR:**

- 1- Turn the reversing switch to position **1**
- 2- Press the **START** button.



**Starting the machine**

**WARNING**

Check carefully that the drum rotation direction is the same as indicated on the belt cover. If not switch off the machine (**STOP** button) and turn the reversing switch lever from position 1 to position 2. Press the **START** button.



**HAZARD**

Using the machine with the wrong drum rotation direction can cause injury/damage to people/objects.

- 12. Observe the operation of the abrasive belt. Follow the Procedures for Centring the Abrasive Belt  
The belt must run inside the tensioning unit (A) and protrude by approximately 2 mm from the rubber drum (B).

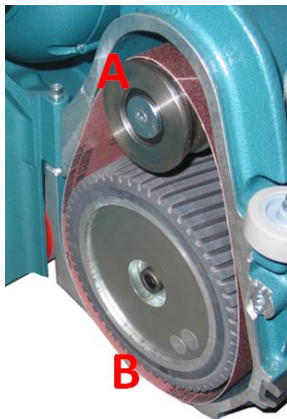

- 13. Close the side guard (fig. C.)

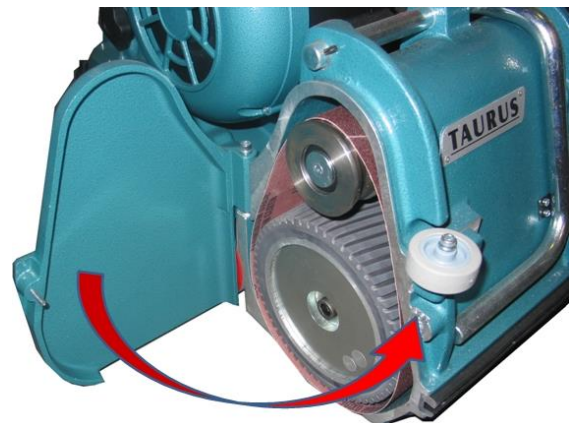

- 14. After lowering the lever (pos. 4 fig. A) commence sanding.



**Starting the machine**

15. To stop the machine:

**a) SINGLE PHASE MOTOR**

Turn the lever of the switch from position **1** to position **0**.



**b) THREE PHASE MOTOR**

Press the **STOP** button.



**IMPORTANT**

If starting the machine is difficult in winter when temperatures are very low remove the abrasive belt and start the motor, letting it idle for several minutes. Replace the belt and repeat the start up operations described above.

**WARNING**

A safety contactor is fitted to the machine. If the power fails when sanding the contactor is activated automatically, stopping the machine from accidentally starting up when the power is restored. To recommence sanding repeat the start-up operations described above.

**Machine adjustment procedures**

**Procedures for centring the abrasive belt**

The belt centres automatically on starting the motor.

**WARNING**

The belt is in the correct position when it protrudes approximately 2 mm from the sanding drum. The belt must run within the tensioning unit (A) and protrude approximately 2 mm from the rubber drum (B)

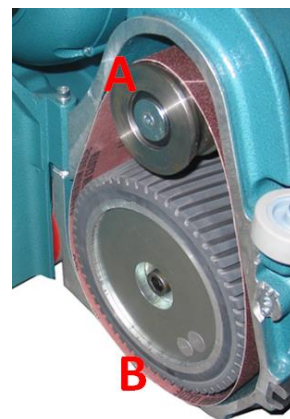

**Machine adjustment procedures**

**Procedures for centring the abrasive belt**

When first fitted the belt may be in the wrong position. In this case use the spanner as shown (**pos. 13 fig. D**) and proceed as follows:

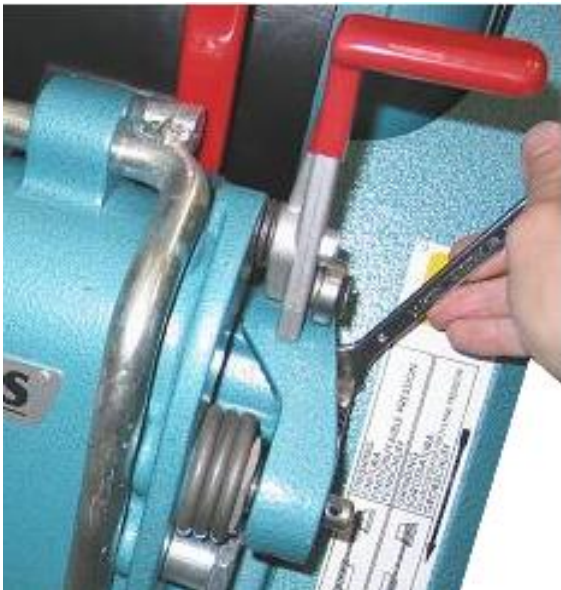

1. Turning the screws clockwise moves the belt towards the outside.
2. Turning the screws anti-clockwise moves the belt towards the inside.

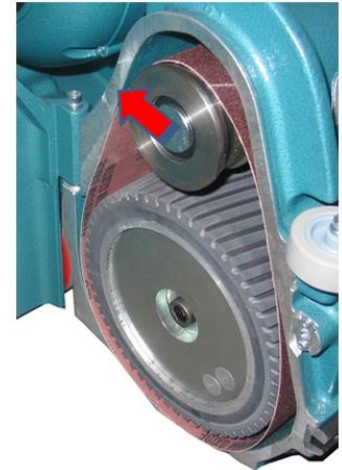
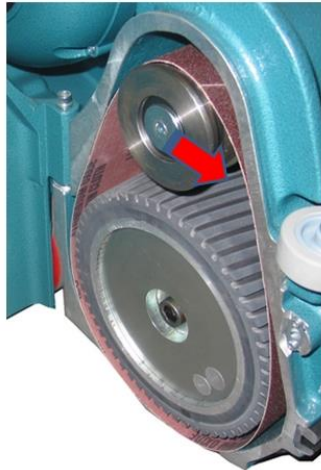

**Adjusting sanding pressure**

To vary drum pressure on the floor, use the adjustment knob (**pos. 14 fig. E**) and proceed as follows:

1. Turn the adjustment knob clockwise to decrease drum pressure on the floor.
2. Turn the adjustment knob anti-clockwise to increase drum pressure on the floor.



**Machine adjustment procedures**

**Wall edge castor**

A support with a free castor has been fitted to avoid damage to the skirting board or wall when sanding along the wall.

**WARNING**

The wall edge castor is correctly positioned when the machine is approximately 8 mm away from the wall with the castor up against it.

Before starting work position the castor correctly by unscrewing the screw (pos. 12 fig. C), moving the support to the required position and tightening the screws.

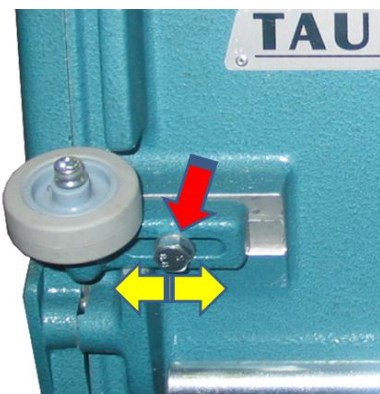

**Wheel adjustment (on a surface parallel to the axis of the drum)**

Before sanding check drum operation on the work surface.

The diagram shows the two possible cases:

- OK = drum and wheels are parallel to the surface to be sanded and the mark left by the drum is the total roller length (approx. 200mm).
- NO = the drum does not rest fully on the surface and only sands at one part, emphasising marking on the floor.

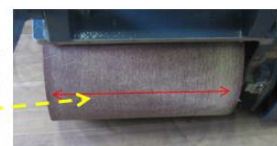

In this case the drum and wheels must be positioned parallel to the surface to be sanded by varying the height of the cam wheel.

**Machine adjustment procedures**

**Wheel adjustment (on a surface parallel to the axis of the drum)**

To adjust proceed as follows:



1. Turn the machine over.
2. With the tool provided with the machine check how much the fixed wheel protrudes.

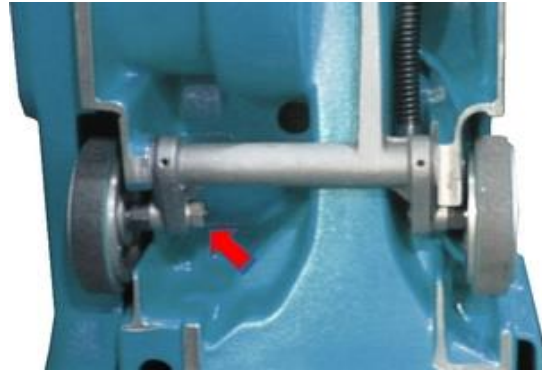

3. Loosen the nut (**pos. 16 fig. F**).
4. Turn the cam pin (**fig. F**) and raise/lower the cam wheel until the wheel protrudes such that the roller operates in parallel to the surface to be sanded.
5. Lock the nut (**pos. 16 fig. F**).

**Routine maintenance to be performed**

To keep the machine in good working condition the following items must be checked and serviced regularly:

**Sawdust chamber (for the user)**

Hoover the sawdust chamber regularly.



**Routine maintenance to be performed**

**Drums (for the user)**

Check the outer surface of the drum regularly.  
Remove any dirt.



**Wheels (for the user)**



Remove dirt from the machine unit and wheels regularly.  
Dirt may cause uneven sanding.

**Dust bag (for the user)**

Remove the bag and shake it well to remove sawdust. Turn the bag inside out and wash it in the machine in cold water to prevent blockage of the pores and a decrease in dust collection ability.





**Routine maintenance to be performed**

**Dust bag (for the user)**

As an alternative to the fabric bag the following may be used:

- a) Disposable paper bags, available in packs of 3 (P/N 6300030142).  
The limit for use is 1/3 of the total capacity.
- b) Remote control industrial vacuum cleaner with tube with maximum length of 10 metres.



**Belt tension (for the user)**

Check belt tension regularly. For adjustment procedures see page 6 of this manual. If the belt is excessively worn it must be replaced.

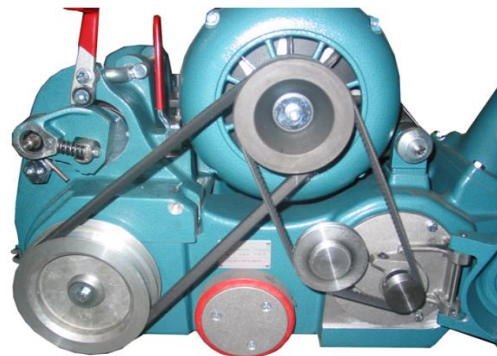

**CAUTION**

**Excessive belt tension may cause the premature failure of the ball bearings. The belt must have a 10.5 mm stretch with a centre load of  $30 \pm 3$  N.**

**Bearings (only for Technical Support Service)**

Check bearings regularly for wear or damage according to the following timescales:

- |               |                            |
|---------------|----------------------------|
| WHEELS:       | after the first 2500 hours |
| FAN SHAFT:    | after the first 2500 hours |
| SANDING DRUM: | after the first 5000 hours |
| MOTOR SHAFT:  | after the first 5000 hours |

**Routine maintenance to be performed**

**Drum pulleys and motor pulleys (for the user)**

Regularly check that the groove (2) of the pulley has not sunk otherwise the belt (1) will operate on the bottom (3) of the pulley itself.

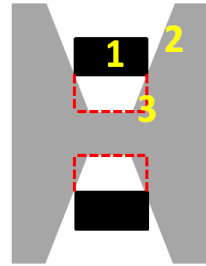
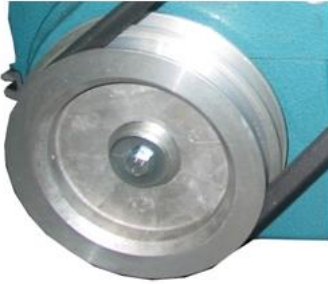

**WARNING**

Pulleys with sunken grooves cause the belts to slip and the correct power will not be transferred to the drum/suction pipe.

For example, this situation can easily occur if the machine loses power during operation. They should therefore be replaced.

**Spare parts**

**Always use K&T spare parts.**

Failure to use K&T spare parts, or repairs/adjustments carried out by unauthorised personnel, will invalidate the guarantee and any resulting liability.

**The machine must only be repaired by qualified personnel.** This electric equipment is compliant with the relevant safety legislation.

Repairs must be carried out by qualified personnel using K&T spare parts, otherwise the user may suffer serious injury.

Emergency situations (for the user)

<b>FAULTS</b>	<b>CAUSES</b>	<b>SOLUTIONS</b>
<b>Insufficient cutting</b>	<i>Unsuitable or worn abrasive</i>	Replace the abrasive
	<i>Insufficient drum pressure</i>	Increase drum pressure
	<i>Insufficient belt tension</i>	Increase belt tension
	<i>Worn belt</i>	Replace the belt
<b>Insufficient motor speed</b>	Insufficient tension due to:	
	<i>Excessive cable length or unsuitable cross section</i>	Use cables of suitable length and cross section
	<i>Unstable connections</i>	Arrange suitable connections
	<i>Faulty capacitor</i>	Contact an authorised K&T dealer
	<i>Faulty motor</i>	Contact an authorised K&T dealer
<b>Scratched work surface</b>	<i>Faulty abrasive</i>	Replace the abrasive
	<i>Drum surface dirty or faulty</i>	Clean/correct/replace the rubber-coated drum.
	<i>Incorrect wheel adjustment</i>	Correct the wheel position
<b>Insufficient dust collection</b>	<i>Dust bag more than 1/3 full</i>	Empty the bag.
	<i>Dust bag dirty or with blocked pores</i>	Shake out the dirt and wash the bag.
	<i>Vacuum ducts and/or obstructed pipes</i>	Clean air ducts
<b>Motor does not start</b>	<i>Faulty switch</i>	Contact an authorised K&T dealer
	<i>Faulty capacitor</i>	Contact an authorised K&T dealer
	<i>Insufficient voltage for unstable connections</i>	Contact an authorised K&T dealer
	<i>Faulty motor</i>	Contact an authorised K&T dealer
	<i>No power supply voltage</i>	Check power supply and connections
<b>Scorching on work surface</b>	<i>Worn abrasive</i>	Replace the abrasive
	<i>Excessive pressure on drum</i>	Decrease sanding pressure
	<i>Abrasive too fine</i>	Use abrasive with larger grain

DECLARATION OF CONFORMITY

2006/95 EC, 2006/42 EC  
2004/108 EC, 2002/95 EC  
2002/96 EC

**KUNZLE & TASIN S.r.l.**

Manufacturer and entity authorised to compile and maintain the technical file

**Registered headquarters**  
Via Circonvallazione Est. 2/6  
27023 Cassolnovo (PV) - Italy

**Business Management and Production Site**  
Via Cajkovskij, 14  
20092 – Cinisello Balsamo (MI) - Italy

**declare that under our sole responsibility the product:**

**WOOD FLOORING SANDER  
BELT HD TAURUS**

**to which this declaration refers, is compliant with the following Directives:  
2006/95 EC (Low Voltage Directive), 2006/42 EC (Machine Directive), 2004/108 EC (EMV),  
2002/95 EC (RoHS), 2002/96 EC (WEEE Directive).**

**The product is compliant with the following harmonised standards:**

- Machine safety - basic concepts, general design principles
- Basic terminology, EN ISO 12100 methodology, Part 1
- Machine safety - basic concepts, general design principles
- Technical principles and EN ISO 12100 specifications, Part 2
- Machine safety - electrical machine equipment
- Part 1: General rules EN 60204-1
- Safety of domestic equipment and similar - General rules
- EN 60 335-1
- Special standards for equipment to treat and clean flooring for industrial and general use - EN 60 335-2-67
- Electromagnetic compatibility (EMC)
- Limits and methods in measuring the characteristics of radio interference in motorised or thermal domestic appliances and similar, electric tools and similar electric devices - EN 55014-1
- Part 3: Limits: Section 2: Limits for the emission of harmonic currents (equipment with input current  $\leq 16$  A per phase) - EN 61000-3-2
- Part 3: Limits: Section 11: Limit of voltage fluctuations and flicker in low voltage power supply systems for equipment with rated current  $\geq 16$  A - EN 61000-3-11

CASSOLNOVO (PV) – 27/09/2012

(place and date of issue)



Michela Caresana - CHIEF EXECUTIVE OFFICER



**Smaltimento di apparecchiature da rottamare da parte di privati nell'Unione Europea.** Questo simbolo che appare sul prodotto o sulla confezione indica che il prodotto non deve essere smaltito assieme ad altri rifiuti domestici. Gli utenti devono provvedere allo smaltimento delle apparecchiature da rottamare portandole al luogo di raccolta indicato per il riciclaggio delle apparecchiature elettriche ed elettroniche. La raccolta e il riciclaggio separati dalle apparecchiature da rottamare in fase di smaltimento favoriscono la conservazione delle risorse naturali e garantiscono che tali apparecchiature vengano rottamate nel rispetto dell'ambiente e della tutela della salute. Per ulteriori informazioni sui punti di raccolta delle apparecchiature da rottamare, contattare il proprio comune di residenza, il servizio di smaltimento dei rifiuti locale o il negozio presso il quale è stato acquistato il prodotto. **Per indicare che questo prodotto comporta requisiti speciali di smaltimento, è stata fissata un'etichetta sul retro del gruppo manico, inoltre essendo presente una fonte di alimentazione esterna, ne è stata fissata un'altra l'etichetta sul retro della scocca della macchina.**



**Disposal of Waste Equipment by Users in Private Households in the European Union.** This symbol on the product or packaging indicates that it must not be disposed of with other household waste. It is your responsibility to dispose of your waste by bringing it to a designated collection point that recycles electrical and electronic waste equipment. The separate collection and recycling of waste at the time of disposal helps to conserve natural resources and ensures it is recycled in a manner that safeguards health and the environment. For more information about where to take waste equipment for recycling, please contact your local council office, household waste disposal service or retailer where you purchased the product. **To indicate that this product has special disposal requirements a label is attached to the back of the handle unit. If an external power supply is included, attach the small label to the back of the power supply.**



**Entsorgung von Ausschusselektrogeräten durch Benutzer in privaten Haushalten in der EU.** Dieses Symbol auf dem Produkt oder dessen Verpackung gibt an, dass das Produkt nicht zusammen mit dem Restmüll entsorgt werden darf. Es obliegt daher Ihrer Verantwortung, das zum Verschrotten bestimmte Gerät an einer für die Entsorgung oder Wiederverwertung von Elektrogeräten aller Art entsprechenden Stelle abzugeben. Die separate Sammlung und das Recycling Ihrer zur Entsorgung bestimmten Elektrogeräte trägt zum Schutz der Umwelt bei und gewährleistet, dass sie auf eine Art und Weise recycelt werden, die keine Gefährdung für die Gesundheit des Menschen und der Umwelt darstellt. Für weitere Informationen darüber, wo Sie alte Elektrogeräte zum Recyceln abgeben können, setzen Sie sich mit den örtlichen Behörden, Wertstoffhöfen im Kontakt oder fragen Sie dort, wo Sie das Gerät erworben haben. **Um darauf hinzuweisen, dass für dieses Produkt spezielle Entsorgungsrichtlinien gelten, wurde auf der Rückseite der Griffgruppe ein Aufkleber angebracht. Außerdem, da eine externe Versorgung im Lieferumfang enthalten ist, wurde ein anderes Aufkleber an der Rückseite der Kalotte angebracht.**



**Élimination des équipements usagés par les utilisateurs dans les foyers privés au sein de l'Union européenne.** La présence de ce symbole sur le produit ou sur son emballage indique que vous ne pouvez pas vous débarrasser de ce produit de la même façon que vos déchets courants. Au contraire, vous êtes responsable de l'évacuation de vos équipements usagés et, à cet effet, vous êtes tenu de les remettre dans un point de collecte agréé pour le recyclage des équipements électriques et électroniques usagés. Le tri, l'évacuation et le recyclage séparés de vos équipements usagés permettent de préserver les ressources naturelles et de s'assurer que ces équipements sont recyclés dans le respect de la santé humaine et de l'environnement. Pour plus d'informations sur les lieux de collecte des équipements usagés, veuillez contacter votre mairie, votre service de traitement des déchets ménagers ou le magasin où vous avez acheté le produit. **Fixez la grande étiquette à l'arrière du produit pour signaler qu'il doit être évacué selon une procédure particulière. Lorsqu'une alimentation externe est fournie, fixez la petite étiquette à l'arrière de celle-ci.**



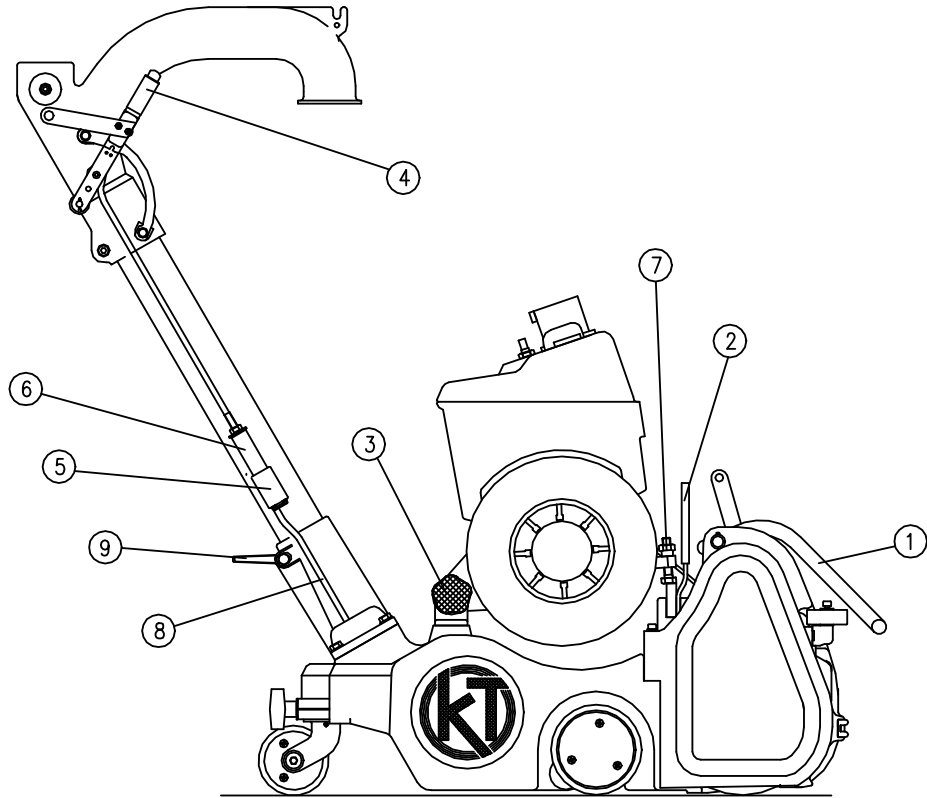

FIG. A

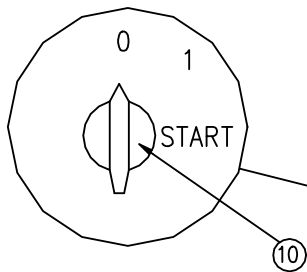

FIG. B

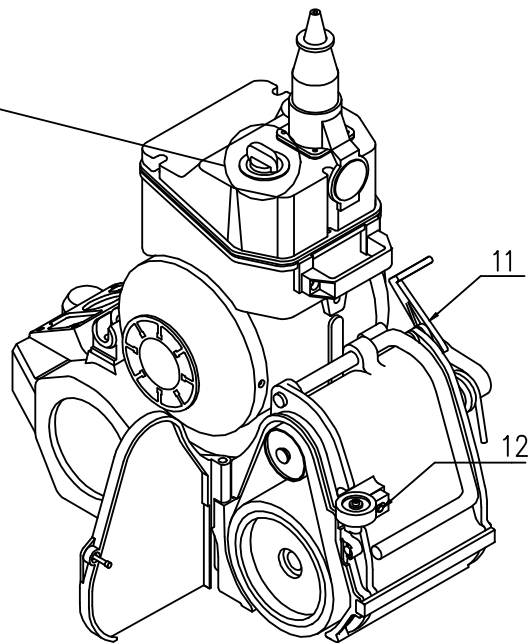

FIG. C

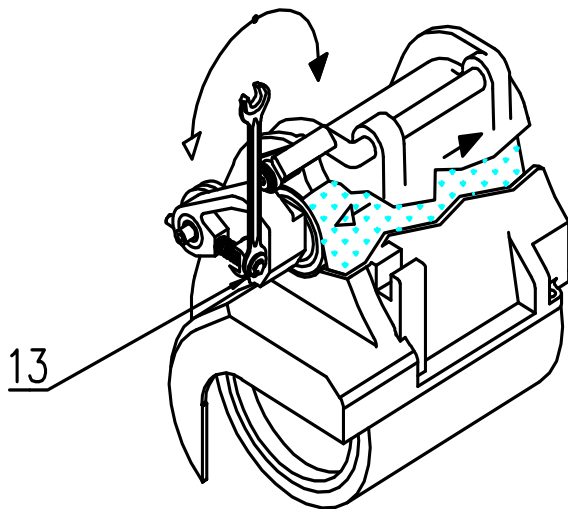

FIG. D

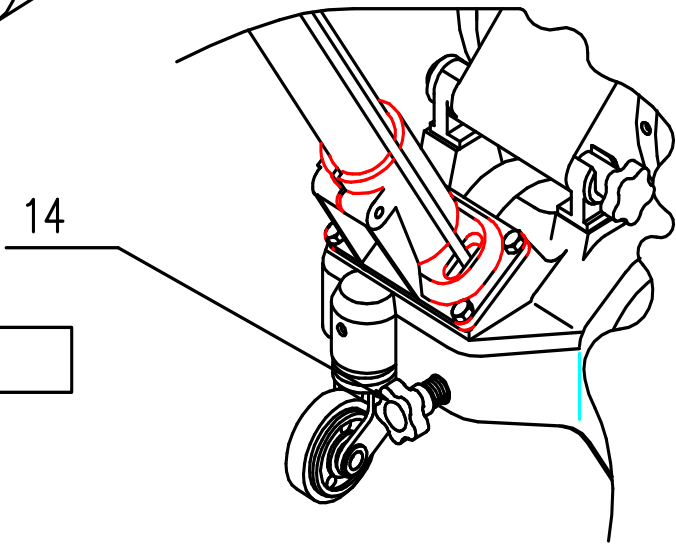

FIG. E

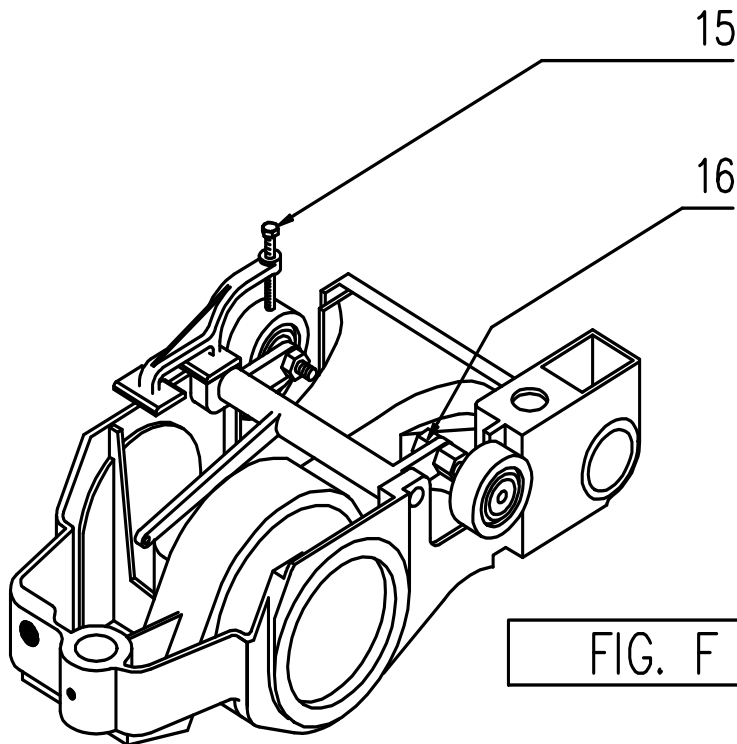

FIG. F



January 2014 Edition